

**Einwegprinzip**

Funktionsweise nach dem Prinzip der Einweglichtschranken. Zwei getrennte Sensorköpfe fungieren als Sender bzw. Empfänger. Die Reichweite ist abhängig vom verwendeten Verstärker.

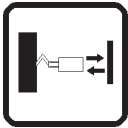

**Taster**

Funktionsweise nach dem Prinzip der Reflexionslichttaster. Sender und Empfänger sind als getrennte Faserbündel in einem Lichtleiter vereint. Die Tastweite ist abhängig vom verwendeten Verstärker.

**Kabelmantel aus Silikon oder Metall**

**Typenschlüssel**

**Beispiel: LLK 2 030 S R B Q - 90 - 4,0 - 2,5**

**Lichtleitkabel**

**Funktionsprinzip**

- 1 = 1-armig (Taster)
- 2 = 2-armig (Sender/Empfänger getrennt)

**Kabellänge in cm**

**Ummantelung**

- S = Silikon
- M = Metall

**Lichtaustritt**

- keine Angabe = axial
- R = radial

**Besonderheiten**

- B = biegsamer Sensorkopf

**Ausführung Sensorkopf**

- keine Angabe = zylindrisch
- Q = Quader

**Biegung Sensorkopf**

- keine Angabe = gerade
- 90 = 90° abgewinkelt (bei Quader: 90 = seitlicher Lichtaustritt)

**Quader**

- bei Quader: aktive Zone in mm

**Zylinder**

- bei Zylinder: Kopfdurchmesser in mm bzw. Gewindemaß M...

**Ø Faserbündel in mm**

**Typenbeispiele**



**zylindrisch, glatt**

Stufentastkopf, 3,5 mm / 5,6 mm glatte Hülse aus Edelstahl. Axialer Lichtaustritt. Verstärkeranschluss mittels Adaption M18. Einsetzbar von -40°C bis + 200°C.



**zylindrisch, Gewinde**

Sensorkopf mit Gewinde M6 aus Edelstahl. Axialer Lichtaustritt. Verstärkeranschluss mittels Adaption M18. Einsetzbar von -40°C bis + 200°C.



**glatte Hülse, radiale Optik**

Glatte Hülse, einseitig abgeflacht mit radialem Lichtaustritt. Länge 35 mm. Verstärkeranschluss mittels Adaption M18. Einsetzbar von -40°C bis + 200°C.

**Einwegprinzip und Taster**

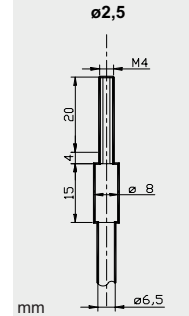
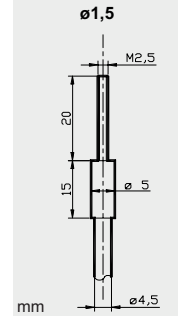
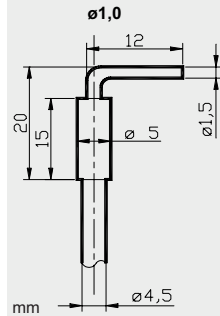
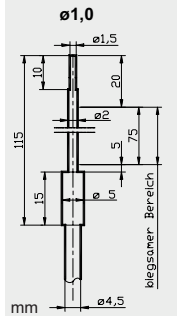
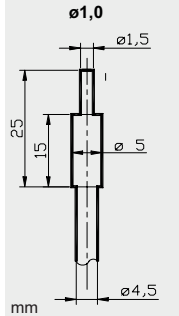
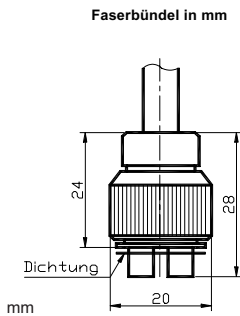

**Taster**

<b>Tastweite (1-armig)</b>	
<b>Ummantelung Länge / mm</b>	
<b>Silikon</b>	300 <b>600</b> 1000
<b>Metall</b>	300 <b>600</b> 1000
<b>fett gedruckt Vorzugstypen</b>	

<b>10mm</b>	<b>10mm</b>	<b>10mm</b>	<b>25mm</b>	<b>40mm</b>
<b>Typ</b>	<b>Typ</b>	<b>Typ</b>	<b>Typ</b>	<b>Typ</b>
LLK1030S-1,5-1,0 <b>LLK1060S-1,5-1,0</b> LLK1100S-1,5-1,0 LLK1030M-1,5-1,0 <b>LLK1060M-1,5-1,0</b> LLK1100M-1,5-1,0	LLK1030SB-2,0-1,0 <b>LLK1060SB-2,0-1,0</b> LLK1100SB-2,0-1,0 LLK1030MB-2,0-1,0 <b>LLK1060MB-2,0-1,0</b> LLK1100MB-2,0-1,0	LLK1030S-90-1,5-1,0 <b>LLK1060S-90-1,5-1,0</b> LLK1100S-90-1,5-1,0 LLK1030M-90-1,5-1,0 <b>LLK1060M-90-1,5-1,0</b> LLK1100M-90-1,5-1,0	LLK1030S-M2,5-1,5 <b>LLK1060S-M2,5-1,5</b> LLK1100S-M2,5-1,5 LLK1030M-M2,5-1,5 <b>LLK1060M-M2,5-1,5</b> LLK1100M-M2,5-1,5	LLK1030S-M4-2,5 <b>LLK1060S-M4-2,5</b> LLK1100S-M4-2,5 LLK1030M-M4-2,5 <b>LLK1060M-M4-2,5</b> LLK1100M-M4-2,5

**Einwegprinzip**

<b>Reichweite (2-armig)</b>	
<b>Ummantelung Länge / mm</b>	
<b>Silikon</b>	300 <b>600</b> 1000
<b>Metall</b>	300 <b>600</b> 1000
<b>fett gedruckt Vorzugstypen</b>	

<b>120mm</b>	<b>120mm</b>	<b>120mm</b>	<b>150mm</b>	<b>600mm</b>
<b>Typ</b>	<b>Typ</b>	<b>Typ</b>	<b>Typ</b>	<b>Typ</b>
LLK2030S-1,5-1,0 <b>LLK2060S-1,5-1,0</b> LLK2100S-1,5-1,0 LLK2030M-1,5-1,0 <b>LLK2060M-1,5-1,0</b> LLK2100M-1,5-1,0	LLK2030SB-2,0-1,0 <b>LLK2060SB-2,0-1,0</b> LLK2100SB-2,0-1,0 LLK2030MB-2,0-1,0 <b>LLK2060MB-2,0-1,0</b> LLK2100MB-2,0-1,0	LLK2030S-90-1,5-1,0 <b>LLK2060S-90-1,5-1,0</b> LLK2100S-90-1,5-1,0 LLK2030M-90-1,5-1,0 <b>LLK2060M-90-1,5-1,0</b> LLK2100M-90-1,5-1,0	LLK2030S-M2,5-1,5 <b>LLK2060S-M2,5-1,5</b> LLK2100S-M2,5-1,5 LLK2030M-M2,5-1,5 <b>LLK2060M-M2,5-1,5</b> LLK2100M-M2,5-1,5	LLK2030S-M4-2,5 <b>LLK2060S-M4-2,5</b> LLK2100S-M4-2,5 LLK2030M-M4-2,5 <b>LLK2060M-M4-2,5</b> LLK2100M-M4-2,5

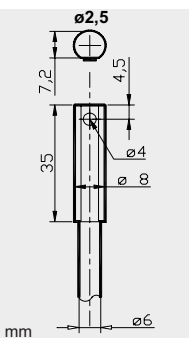
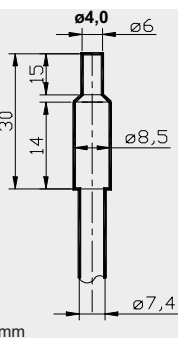
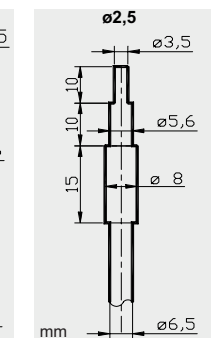
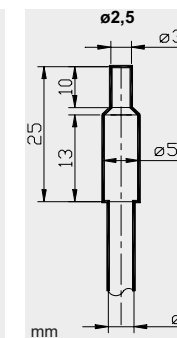
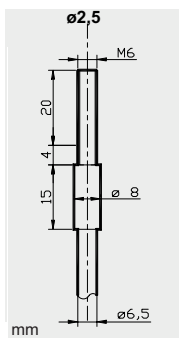
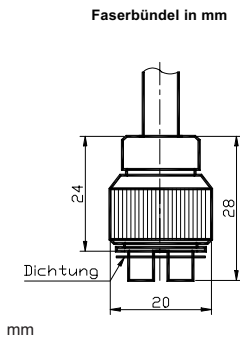

**Taster**

<b>Tastweite (1-armig)</b>	
<b>Ummantelung Länge / mm</b>	
<b>Silikon</b>	300 <b>600</b> 1000
<b>Metall</b>	300 <b>600</b> 1000
<b>fett gedruckt Vorzugstypen</b>	

<b>40mm</b>	<b>40mm</b>	<b>40mm</b>	<b>80mm</b>	<b>50mm</b>
<b>Typ</b>	<b>Typ</b>	<b>Typ</b>	<b>Typ</b>	<b>Typ</b>
LLK1030S-M6-2,5 <b>LLK1060S-M6-2,5</b> LLK1100S-M6-2,5 LLK1030M-M6-2,5 <b>LLK1060M-M6-2,5</b> LLK1100M-M6-2,5	LLK1030S-5,6-2,5 <b>LLK1060S-5,6-2,5</b> LLK1100S-5,6-2,5 LLK1030M-5,6-2,5 <b>LLK1060M-5,6-2,5</b> LLK1100M-5,6-2,5	LLK1030S-8,0-2,5 <b>LLK1060S-8,0-2,5</b> LLK1100S-8,0-2,5 LLK1030M-8,0-2,5 <b>LLK1060M-8,0-2,5</b> LLK1100M-8,0-2,5	LLK1030S-8,5-4,0 <b>LLK1060S-8,5-4,0</b> LLK1100S-8,5-4,0 LLK1030M-8,5-4,0 <b>LLK1060M-8,5-4,0</b> LLK1100M-8,5-4,0	LLK1030SR-8,0-2,5 <b>LLK1060SR-8,0-2,5</b> LLK1100SR-8,0-2,5 LLK1030MR-8,0-2,5 <b>LLK1060MR-8,0-2,5</b> LLK1100MR-8,0-2,5

**Einwegprinzip**

<b>Reichweite (2-armig)</b>	
<b>Ummantelung Länge / mm</b>	
<b>Silikon</b>	300 <b>600</b> 1000
<b>Metall</b>	300 <b>600</b> 1000
<b>fett gedruckt Vorzugstypen</b>	

<b>800mm</b>	<b>600mm</b>	<b>600mm</b>	<b>800mm</b>	<b>500mm</b>
<b>Typ</b>	<b>Typ</b>	<b>Typ</b>	<b>Typ</b>	<b>Typ</b>
LLK2030S-M6-2,5 <b>LLK2060S-M6-2,5</b> LLK2100S-M6-2,5 LLK2030M-M6-2,5 <b>LLK2060M-M6-2,5</b> LLK2100M-M6-2,5	LLK2030S-5,6-2,5 <b>LLK2060S-5,6-2,5</b> LLK2100S-5,6-2,5 LLK2030M-5,6-2,5 <b>LLK2060M-5,6-2,5</b> LLK2100M-5,6-2,5	LLK2030S-8,0-2,5 <b>LLK2060S-8,0-2,5</b> LLK2100S-8,0-2,5 LLK2030M-8,0-2,5 <b>LLK2060M-8,0-2,5</b> LLK2100M-8,0-2,5	LLK2030S-8,5-4,0 <b>LLK2060S-8,5-4,0</b> LLK2100S-8,5-4,0 LLK2030M-8,5-4,0 <b>LLK2060M-8,5-4,0</b> LLK2100M-8,5-4,0	LLK2030SR-8,0-2,5 <b>LLK2060SR-8,0-2,5</b> LLK2100SR-8,0-2,5 LLK2030MR-8,0-2,5 <b>LLK2060MR-8,0-2,5</b> LLK2100MR-8,0-2,5

\* Sonderausführungen können auf Anfrage konfektioniert werden  
\* Passende Verstärkerbaureihe: OLK(T) 40...

**Einwegprinzip und Taster**



**Taster**

<b>Tastweite (1-armig)</b>	
<b>Ummantelung Länge / mm</b>	
<b>Silikon</b>	300
	<b>600</b>
	1000
<b>Metall</b>	300
	<b>600</b>
	1000
fett gedruckt Vorzugstypen	

<b>40mm</b>
<b>Typ</b>
LLK1030S-90-4,0-2,5
<b>LLK1060S-90-4,0-2,5</b>
LLK1100S-90-4,0-2,5
LLK1030M-90-4,0-2,5
<b>LLK1060M-90-4,0-2,5</b>
LLK1100M-90-4,0-2,5

<b>80mm</b>
<b>Typ</b>
LLK1030SQ-10-0,6
<b>LLK1060SQ-10-0,6</b>
LLK1100SQ-10-0,6
LLK1030MQ-10-0,6
<b>LLK1060MQ-10-0,6</b>
LLK1100MQ-10-0,6

<b>80mm</b>
<b>Typ</b>
LLK1030SQ-90-10-0,6
<b>LLK1060SQ-90-10-0,6</b>
LLK1100SQ-90-10-0,6
LLK1030MQ-90-10-0,6
<b>LLK1060MQ-90-10-0,6</b>
LLK1100MQ-90-10-0,6

**Einwegprinzip**

<b>Reichweite (2-armig)</b>	
<b>Ummantelung Länge / mm</b>	
<b>Silikon</b>	300
	<b>600</b>
	1000
<b>Metall</b>	300
	<b>600</b>
	1000
fett gedruckt Vorzugstypen	

<b>1000mm</b>
<b>Typ</b>
LLK2030S-90-4,0-2,5
<b>LLK2060S-90-4,0-2,5</b>
LLK2100S-90-4,0-2,5
LLK2030M-90-4,0-2,5
<b>LLK2060M-90-4,0-2,5</b>
LLK2100M-90-4,0-2,5

<b>800mm</b>
<b>Typ</b>
LLK2030SQ-10-0,3
<b>LLK2060SQ-10-0,3</b>
LLK2100SQ-10-0,3
LLK2030MQ-10-0,3
<b>LLK2060MQ-10-0,3</b>
LLK2100MQ-10-0,3

<b>800mm</b>
<b>Typ</b>
LLK2030SQ-90-10-0,3
<b>LLK2060SQ-90-10-0,3</b>
LLK2100SQ-90-10-0,3
LLK2030MQ-90-10-0,3
<b>LLK2060MQ-90-10-0,3</b>
LLK2100MQ-90-10-0,3

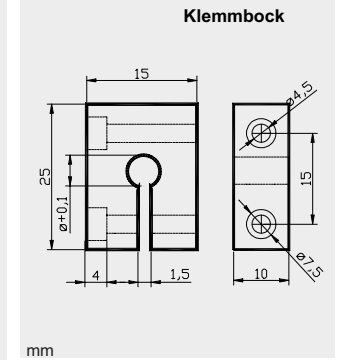
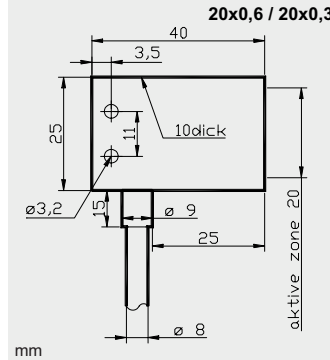
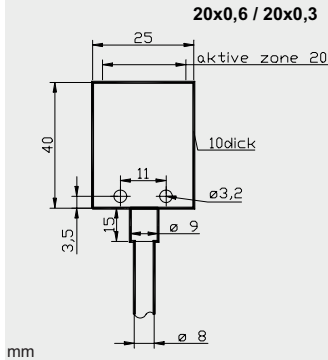

**Taster**

<b>Tastweite (1-armig)</b>	
<b>Ummantelung Länge / mm</b>	
<b>Silikon</b>	300
	<b>600</b>
	1000
<b>Metall</b>	300
	<b>600</b>
	1000
fett gedruckt Vorzugstypen	

<b>100mm</b>
<b>Typ</b>
LLK1030SQ-20-0,6
<b>LLK1060SQ-20-0,6</b>
LLK1100SQ-20-0,6
LLK1030MQ-20-0,6
<b>LLK1060MQ-20-0,6</b>
LLK1100MQ-20-0,6

<b>100mm</b>
<b>Typ</b>
LLK1030SQ-90-20-0,6
<b>LLK1060SQ-90-20-0,6</b>
LLK1100SQ-90-20-0,6
LLK1030MQ-90-20-0,6
<b>LLK1060MQ-90-20-0,6</b>
LLK1100MQ-90-20-0,6

<b>ø in mm</b>	<b>Typ</b>
3,5mm	<b>KLB35</b>
5,0mm	<b>KLB50</b>
5,6mm	<b>KLB56</b>
6,5mm	<b>KLB65</b>
8,0mm	<b>KLB80</b>
8,5mm	<b>KLB85</b>

**Einwegprinzip**

<b>Reichweite (2-armig)</b>	
<b>Ummantelung Länge / mm</b>	
<b>Silikon</b>	300
	<b>600</b>
	1000
<b>Metall</b>	300
	<b>600</b>
	1000
fett gedruckt Vorzugstypen	

<b>1000mm</b>
<b>Typ</b>
LLK2030SQ-20-0,3
<b>LLK2060SQ-20-0,3</b>
LLK2100SQ-20-0,3
LLK2030MQ-20-0,3
<b>LLK2060MQ-20-0,3</b>
LLK2100MQ-20-0,3

<b>1000mm</b>
<b>Typ</b>
LLK2030SQ-90-20-0,3
<b>LLK2060SQ-90-20-0,3</b>
LLK2100SQ-90-20-0,3
LLK2030MQ-90-20-0,3
<b>LLK2060MQ-90-20-0,3</b>
LLK2100MQ-90-20-0,3